

Assembly Instructions

BUG-2 CART

Distributed by:

MEDICAL
CART COMPANY

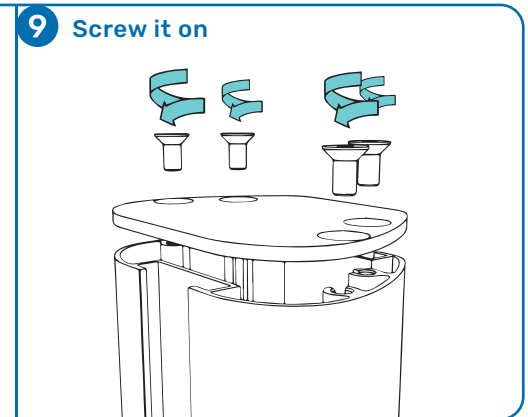
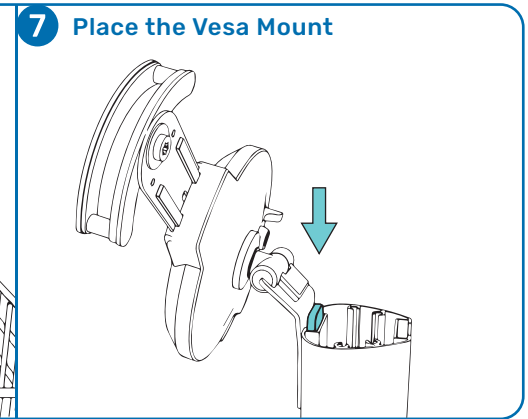
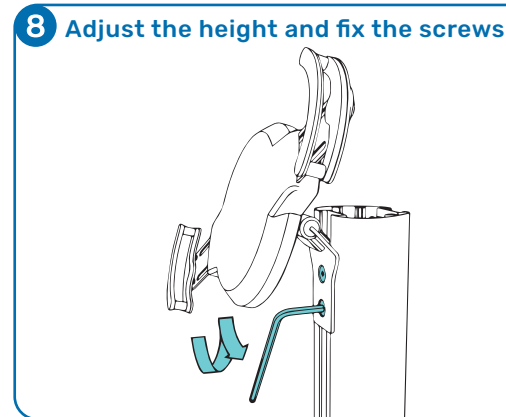
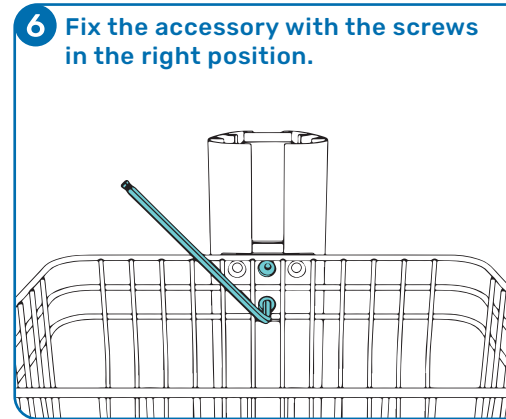
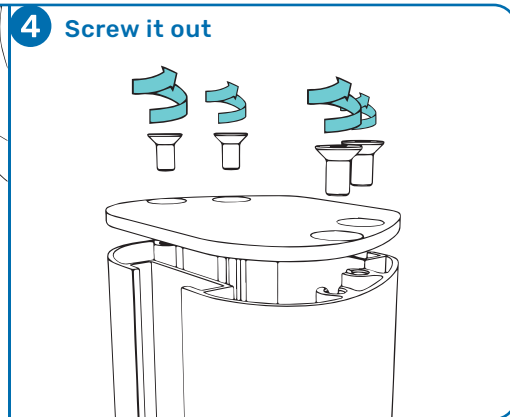
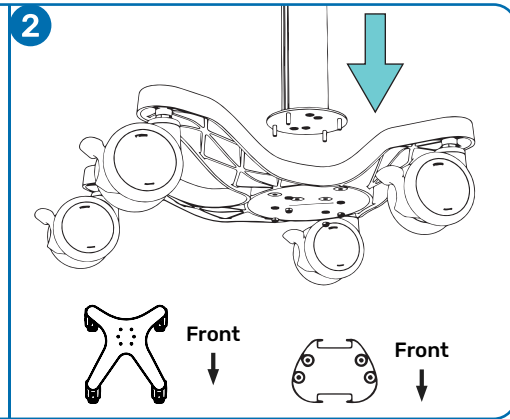
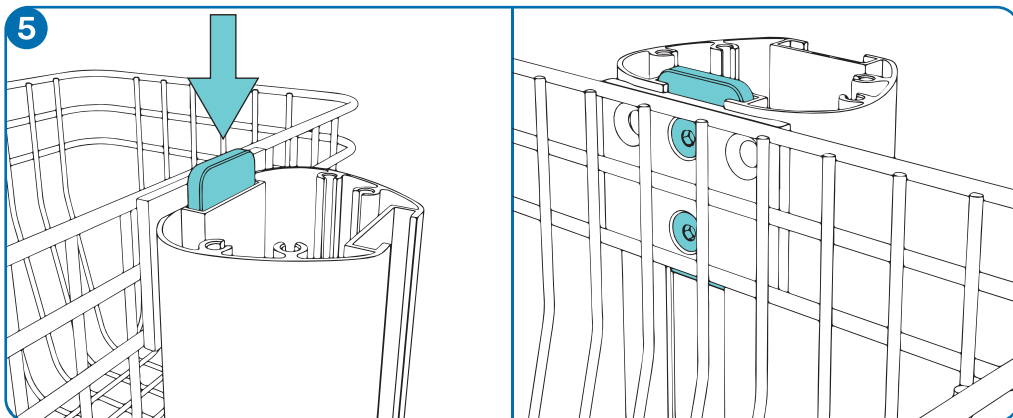
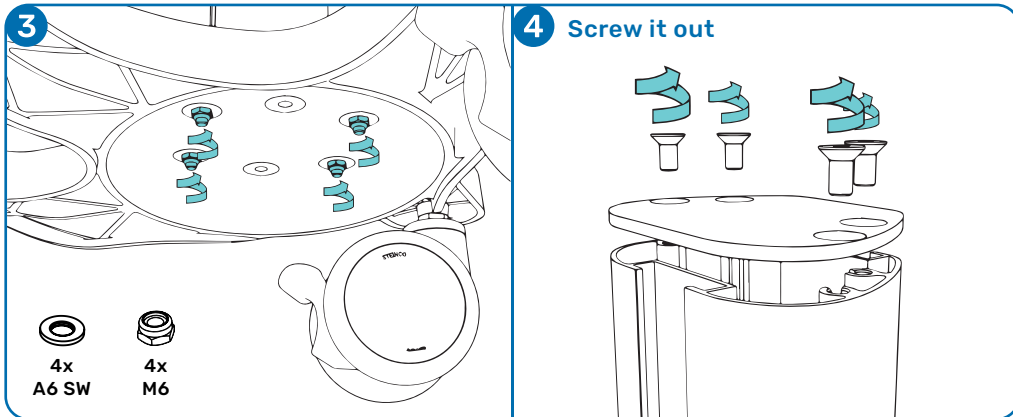
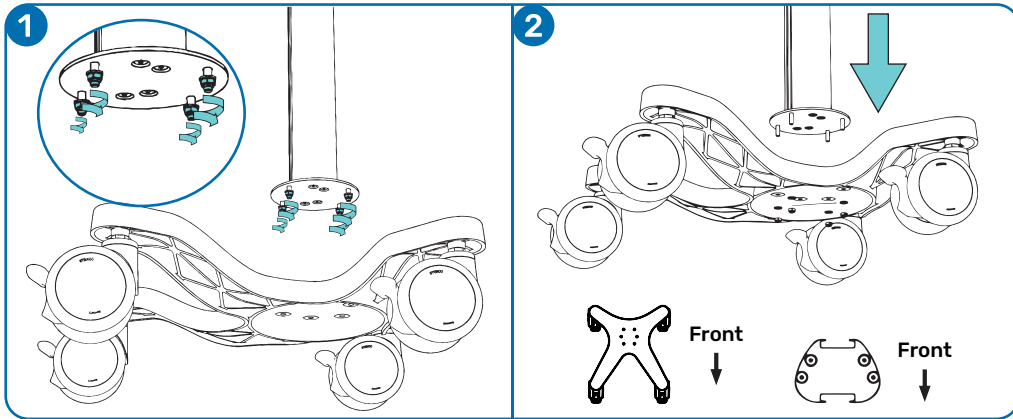

! We are using a rail in the column to fix accessories. Mind the order of the accessories before fixing them! **!**



Assembly Instructions BUG-2 CART

! Cleaning Procedure

1. The cart may be cleaned with most mild, non-abrasive solutions commonly used in the hospital environment such as diluted bleach, ammonia, or alcohol solutions.
2. The surface finish will be permanently damaged by strong chemicals and solvents such as acetone and trichloroethylen.
3. Do not use steel wool or other abrasive material to clean the mounting assembly.
4. Damage caused by the use of unapproved substances or processes will not be covered by warranty. We recommended that you test any cleaning solution on a small area of the arm that is not visible to verify compatibility.
5. Wipe any cleaning agents off of the arm immediately using a water-dampened cloth. Dry the cart thoroughly after cleaning.

CAUTION: Medical Cart Company makes no claims regarding the efficacy of the listed chemicals or processes as a means for controlling infection. Consult your hospital's infection control officer or epidemiologist. To clean or sterilize mounted instruments or accessory equipment, refer to the specific instructions delivered with those products.

! Installation and Maintenance Warnings

This section contains warnings regarding the assembly and maintenance of the Budgie Cart. This section must be read in its entirety before installing and maintaining the Budgie Cart. Failure to follow these warnings may result in damage to equipment or injury to personnel.

- Medical Cart Company has been tip tested to verify stability of the complete cart. Configurations differing from approved Medical Cart Company specifications should be tip tested to ensure safe operation and prevent any stability/tip hazards. Contact Medical Cart Company for further information.
- Please consider carefully the mounted equipment and proximity of cart to other equipment, hospital personnel and the patient.
- When moving the Budgie Cart fold any extended mounts with equipment inward to prevent collisions with other equipment, walls, doorways, hospital personnel and the patient.
- Periodically inspect Budgie Cart components and fasteners for looseness. Tighten as required or optimal operation and safety.

Allowable Cleaning Solutions

- General purpose detergent
- Alcohol (70% Isopronanol)
- Chlorine (10,000 PPM)

 **Use designated handle only for moving the cart**

 **Read Instructions!**

! Information

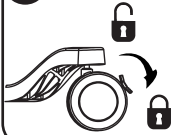
 **Locking Castors**

Rotate lever downwards to lock the castor.

Always lock the cart castors when not moving the cart.

! Warning



Take care when fitting the work surface as until it is properly secured, there is a risk of it slipping or falling.

! Movement



Only move by hand. Take care not to over tighten as this may strip the threads.

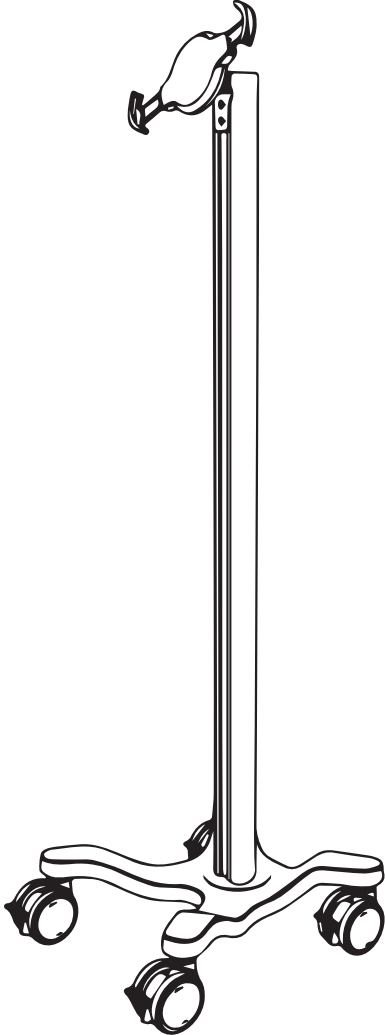

Manufactured by: 

Medical Cart Company Kft.
2051 Biatorbágy, Hungary
Vendel park, Tormásrét utca 12. 