

SNAKE ARM SOLUTIONS

2025

Medical Cart
COMPANY

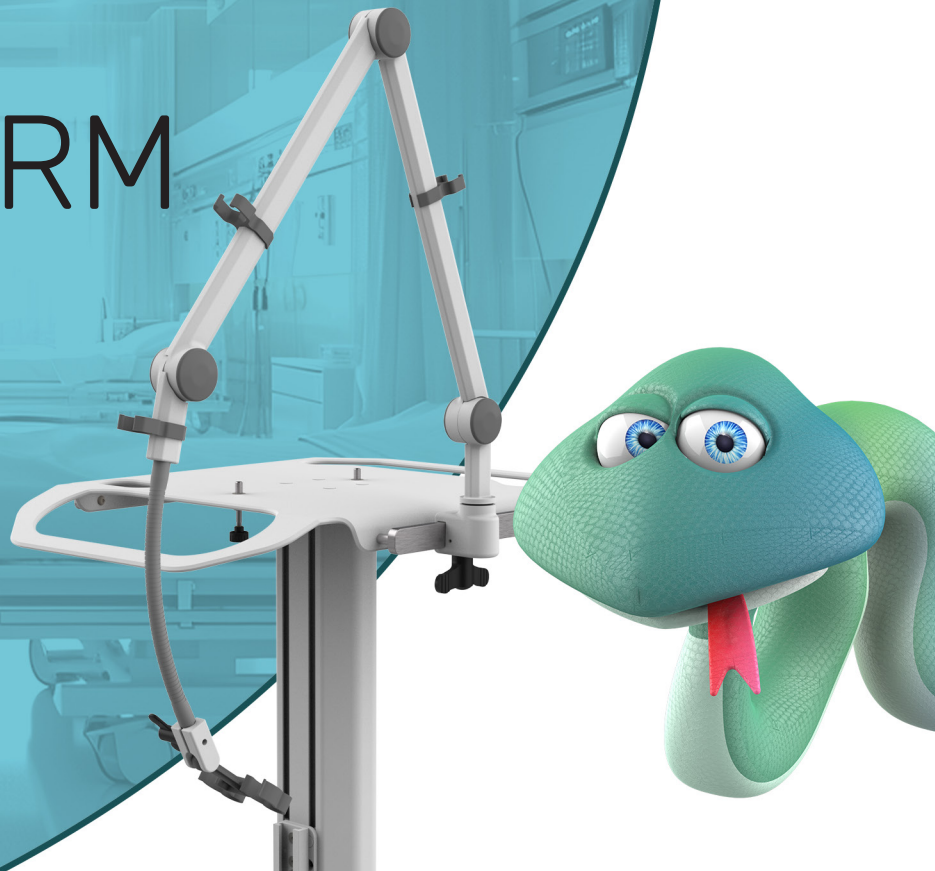

GENERAL FEATURES



EASY TO CLEAN SURFACES

Clean surfaces without dirt traps.
One wipe cleaning.



QUICK SETUP

Available assembled or
flat-packed, easy to assemble.



8 YEARS WARRANTY

Eight-year warranty for
the care-free treatment.



ERGONOMIC

Designed for easy
and comfortable use.

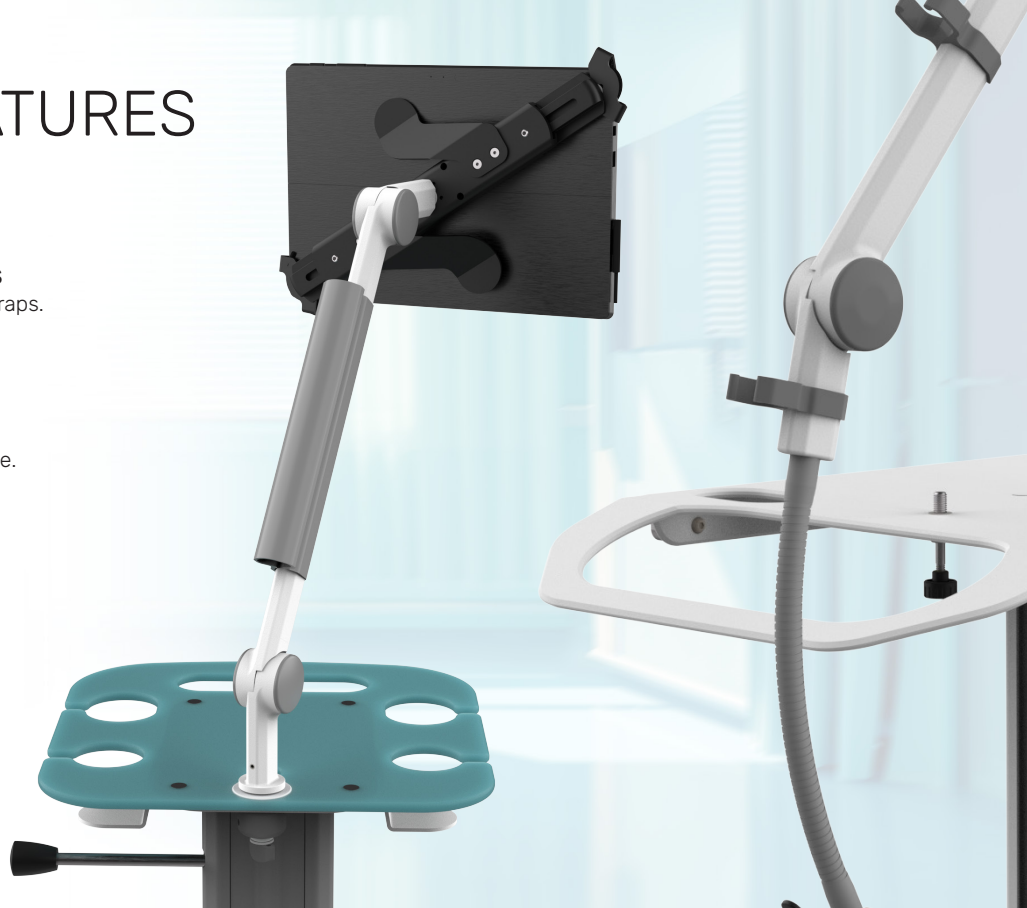

CORE PRODUCT

Datasheet
Scan the QR

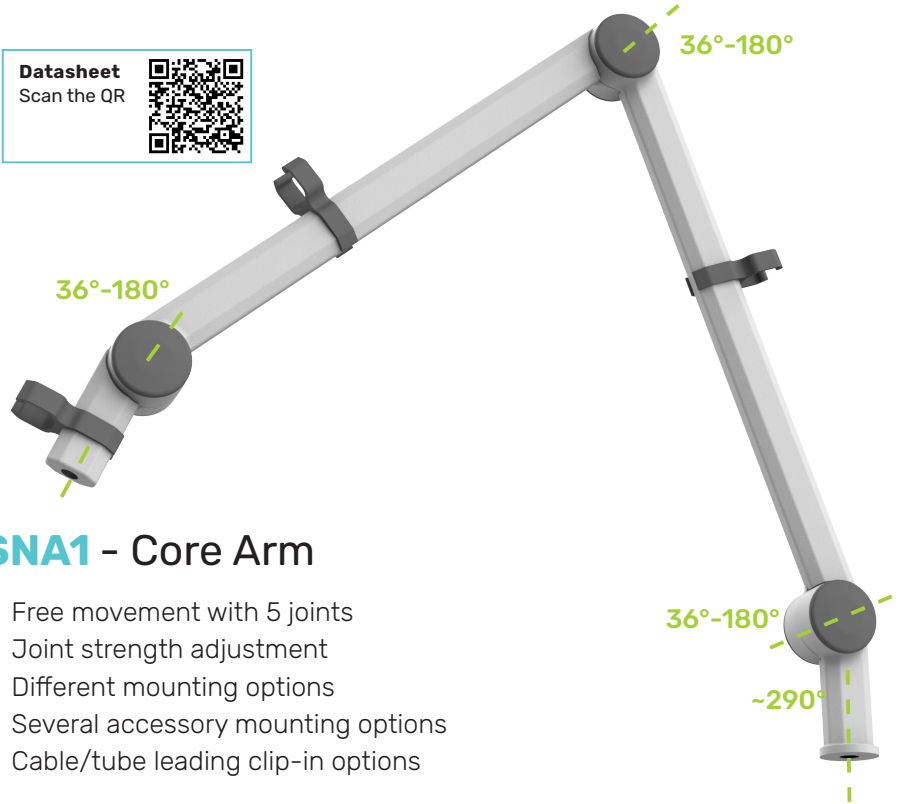

SNA1 - Core Arm

- Free movement with 5 joints
- Joint strength adjustment
- Different mounting options
- Several accessory mounting options
- Cable/tube leading clip-in options

MOUNTING OPTIONS

The circuit arm can be mounted on several medical parts: DIN rail fitting, Medical Cart Company's columns or Worktops.



ACCESSORY OPTIONS

We offer a series of components which can be mounted on the Arm's end. These serve as Module/Tablet/Display holders or the mounting of other parts such as breathing tubes.

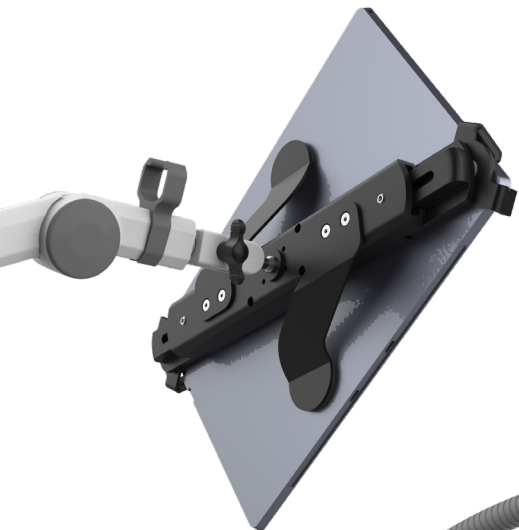

ARM CONFIGURATOR

Example:

SNA1-DR-L3-FLH1-A

RANGE

- 1. MOUNTING
- 2. MIDDLE SECTION
- 3. ACCESSORY
- 4. CLIP-IN



**MOUNTING
OPTIONS**

S2A



WS



WS2



DR

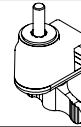

C2M

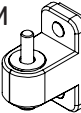

C5M

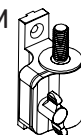

PM

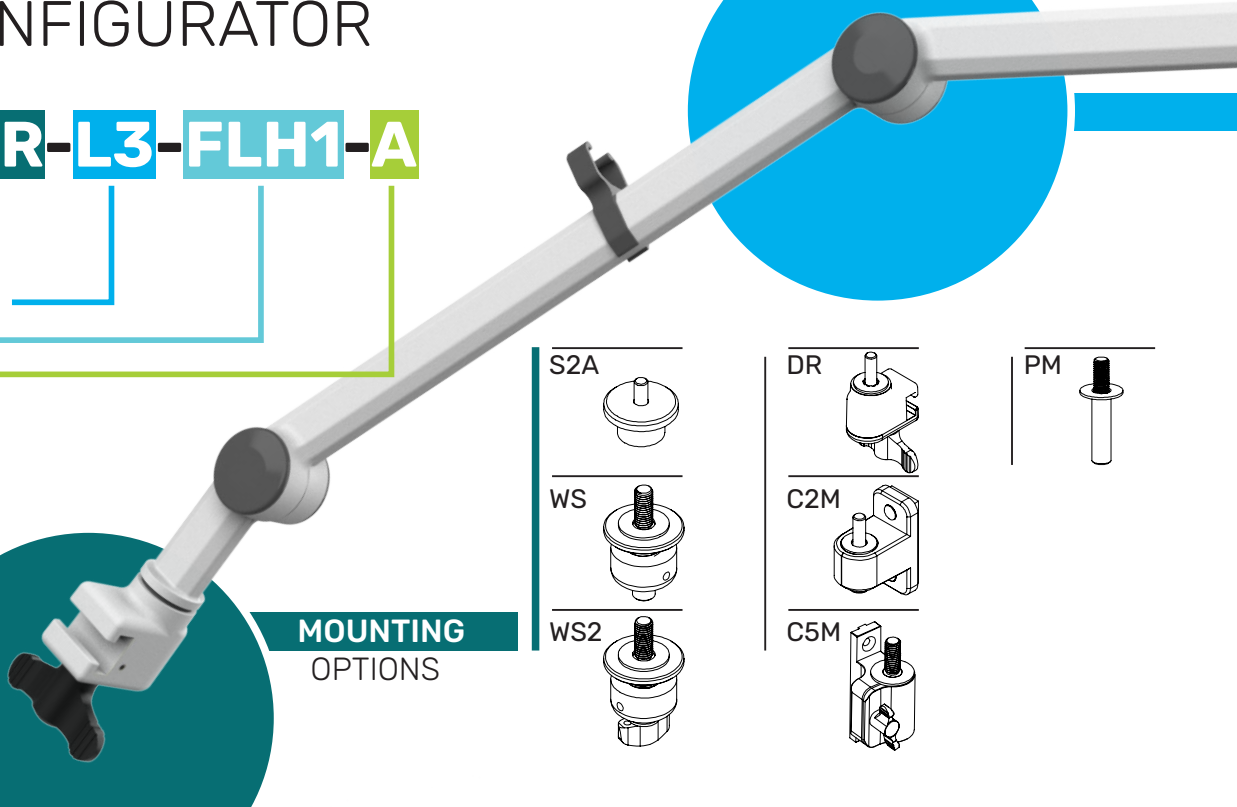
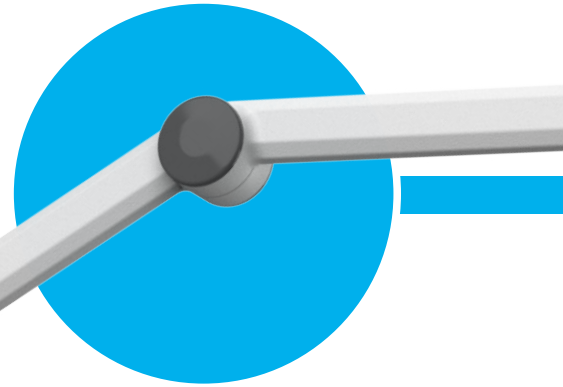

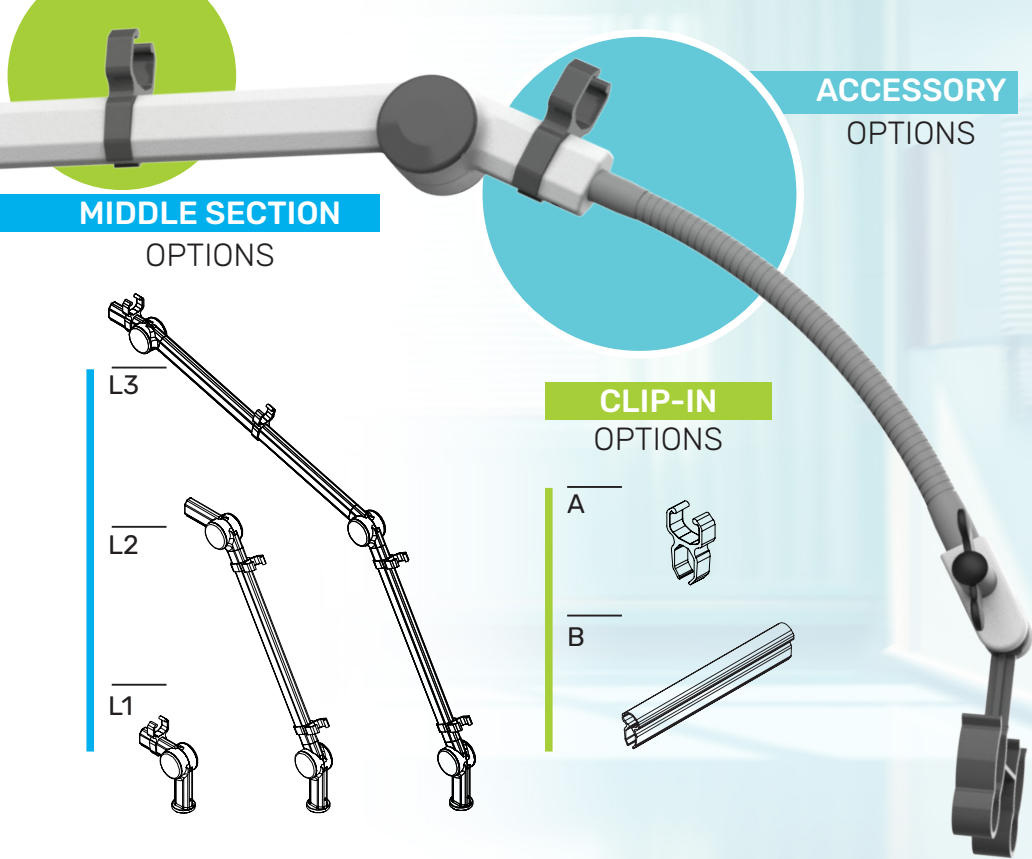

MIDDLE SECTION

OPTIONS

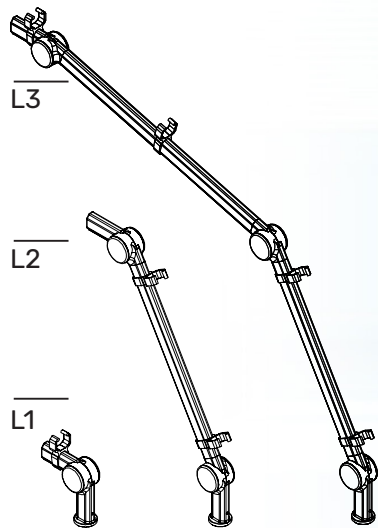

ACCESSORY OPTIONS

CLIP-IN OPTIONS

A



B

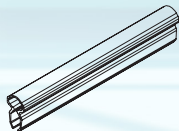

FLH1

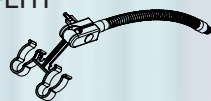

FLH2

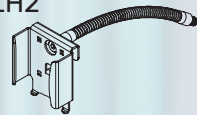

FLH3

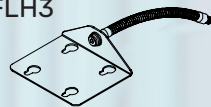

SCK



FTM2



BTM2

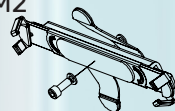

TM2

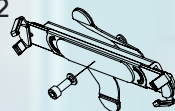

VES1

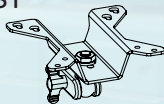

MDH1

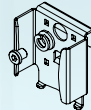

MDH2

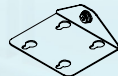

Medical Cart C O M P A N Y



Medical Cart Company Kft.

2051 Hungary

Biatorbágy, Budai út 16.

Phone: +36 23 920 790

Email: info@medicalcartcompany.hu

www.medicalcartcompany.hu